

# Maris Topmount Sink - MAG61023-SHG | 114.0687.049

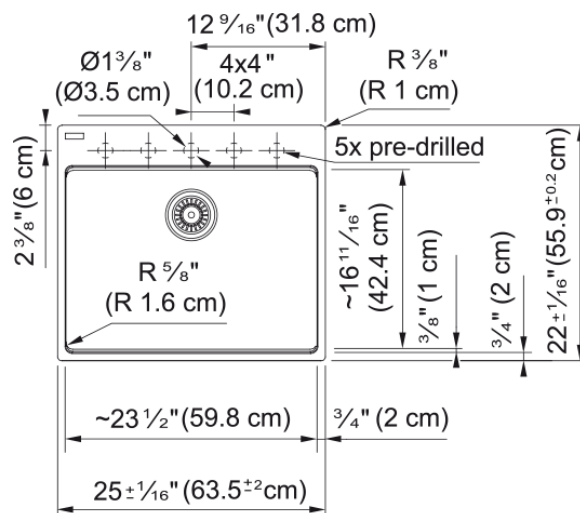

## Technical Data

### Aspect

Sink type	Sink
Type of material	Granite
Number of bowls	1
Color	Stone grey
Finish	None

### Product Dimensions

Exterior size: right to left	25
Exterior size: front to back	22.008
Large bowl size: right to left	23.465
Large bowl size: front to back	16.614
Large bowl: depth	9.488

### Installation

Minimum cabinet size	27"
----------------------	-----

### Product specifications

Installation type	Topmount / drop in
Drain hole	3 1/2"
Position of drainer	No drainer

### Product identification

Product brand	FRANKE
Product family	Maris
Collection	Maris
Certified by	IAPMO

### Features

Drainers number	No drainer
Product reversibility	No
Faucet ledge	Yes
Strainer assembly included	No

## Features

Strainer assembly type	No waste kit
Overflow	No
Number of faucet holes	5 - pre-scored
Soap dispenser hole	No