

SHOWER
Vintage Pressure Balancing
Shower System - Tub and Shower
G-7216-C18B

GRAFF®



Information

- 1/2" pressure balance valve with diverter and trim
- 9" showerhead with 11" wall-mounted shower arm
- Showerhead features no-clog, easy-clean spray nozzles
- 7-1/2" matching Vintage collection tub spout
- Optional extension kit
- Showerhead flow rate ≤ 1.8 max gpm
- CALGreen

SHOWER
Vintage Pressure Balancing Valve
Trim with Handle and Diverter

GRAFF®



Information

- Single metal handle
- Decorative trim plate
- Includes push-button diverter
- Use with G-7055 Pressure Balancing Rough Valve

Finishes



24K Gold



24K Brushed Gold



24K Brushed Gold with Black Accents



Architectural Black™



Brushed Nickel



Gunmetal



Matte Black

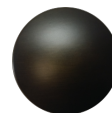

Olive Bronze



Polished Chrome



Polished Chrome with Black Accents



Polished Nickel



Polished Nickel with Black Accents



Unfinished Brass

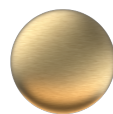

Unfinished Brushed Brass

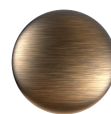

Vintage Brushed Brass

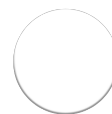

Architectural White

G-7095-C18B-T

VINTAGE Series

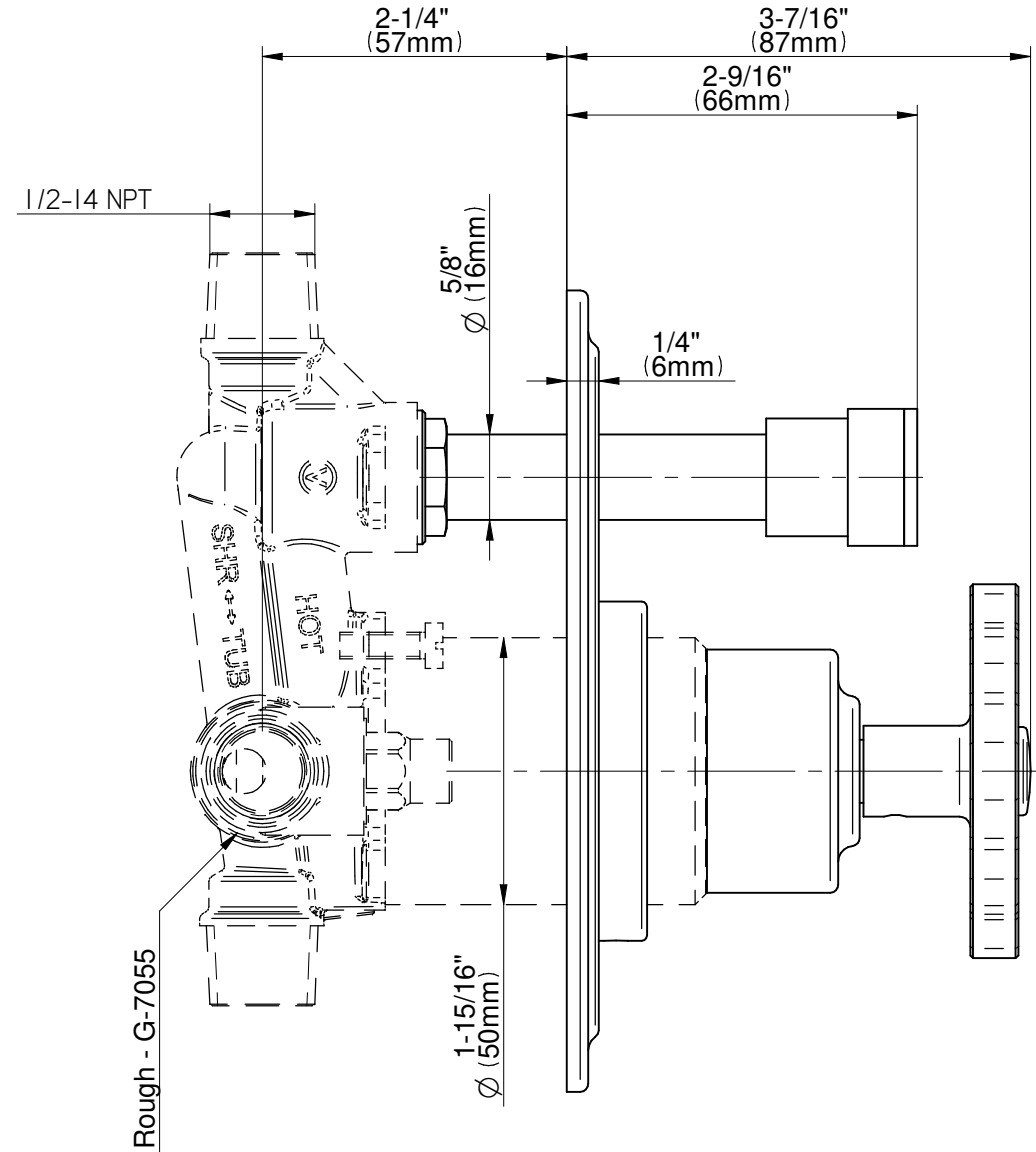
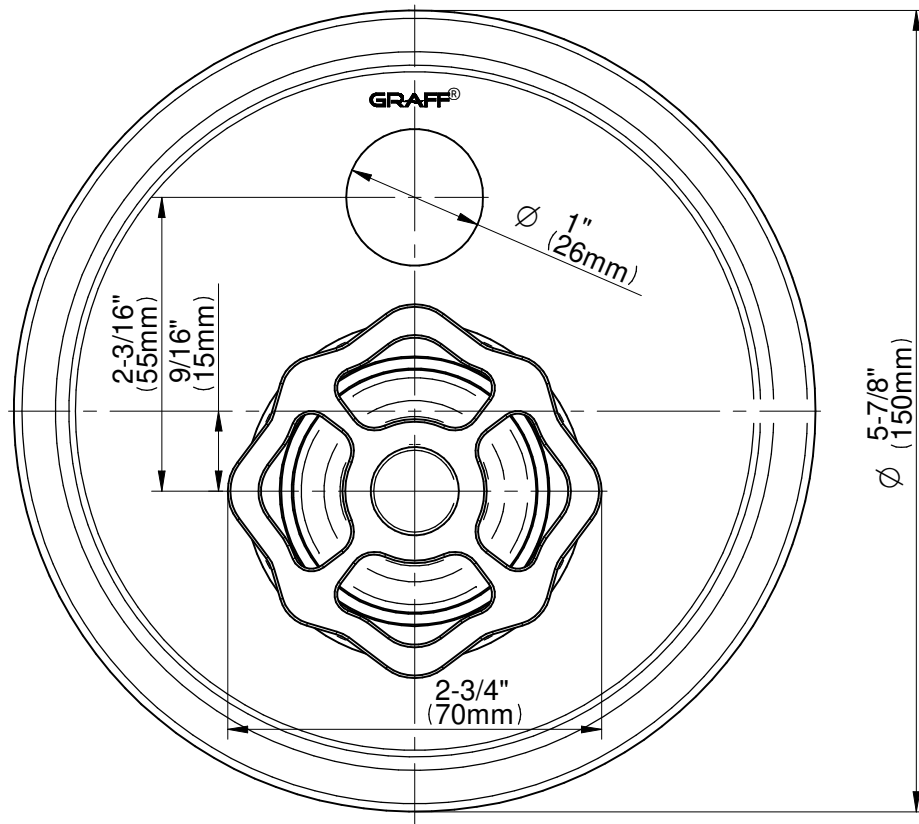

SHOWER
7-1/2" Vintage Tub Spout
G-11365

GRAFF[®]



Information

- Includes spout ring
- 1/2" NPT male thread inlet
- Tub spout flow rate ~ 12.4 gpm @60 psi

Finishes



24K Gold



24K Brushed Gold



24K Brushed Gold with Black Accents



Architectural Black™



Brushed Nickel



Gunmetal



Matte Black

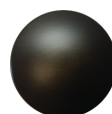

Olive Bronze



Polished Chrome



Polished Chrome with Black Accents



Polished Nickel



Polished Nickel with Black Accents

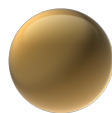

Unfinished Brass

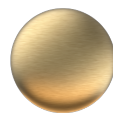

Unfinished Brushed Brass

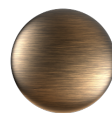

Vintage Brushed Brass

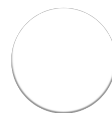

Architectural White

G-11365

Vintage Series

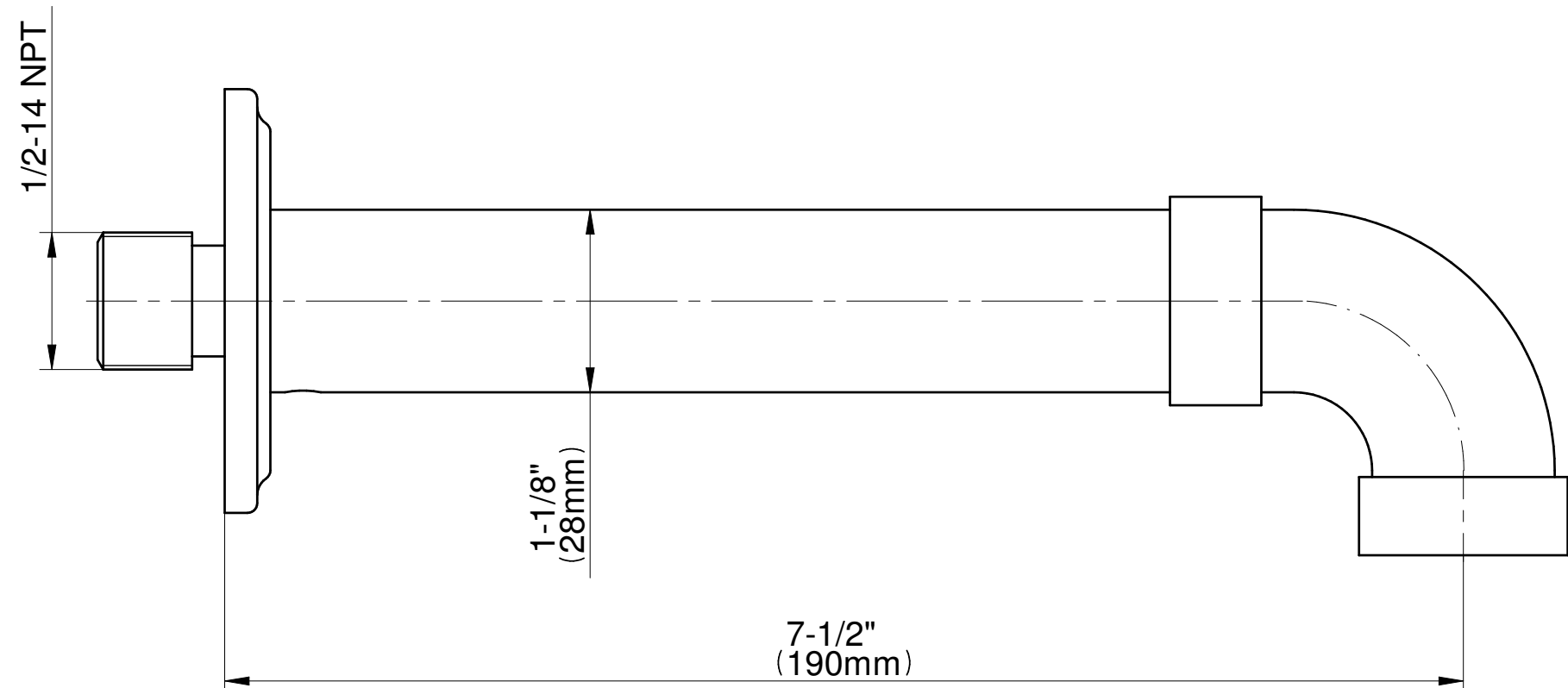
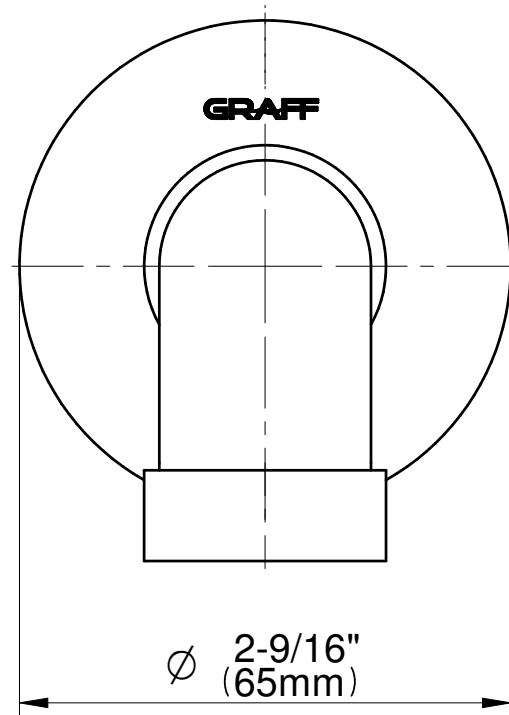

SHOWER
 Concealed Pressure Balancing
 Valve Rough w/Diverter
G-7055



Information

- Anti-scald protection
- 1/2" universal inlets/outlets with male threads
- Built-in service stops
- Push-button diverter
- For use with tub & shower configuration
- Supplied with protective plastic guard

Finishes



24K Gold



24K Brushed Gold



24K Brushed Gold with Black Accents



Architectural Black™

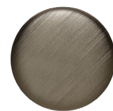

Brushed Nickel



Gunmetal



Matte Black

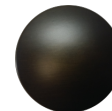

Olive Bronze



Polished Chrome



Polished Chrome with Black Accents



Polished Nickel



Polished Nickel with Black Accents

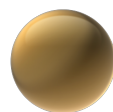

Unfinished Brass

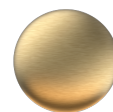

Unfinished Brushed Brass

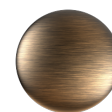

Vintage Brushed Brass



Architectural White

G-7055

1/2" Rough Valve w/Diverter



Product Features

- Anti-scald protection
- 1/2" universal inlets/outlets with male threads
- Built-in service stops
- Push-button diverter
- For use with tub & shower configuration
- Supplied with protective plastic guard

Warranty

- Limited lifetime warranty

For complete warranty information go to www.graff-faucets.com/en-nam/warranty

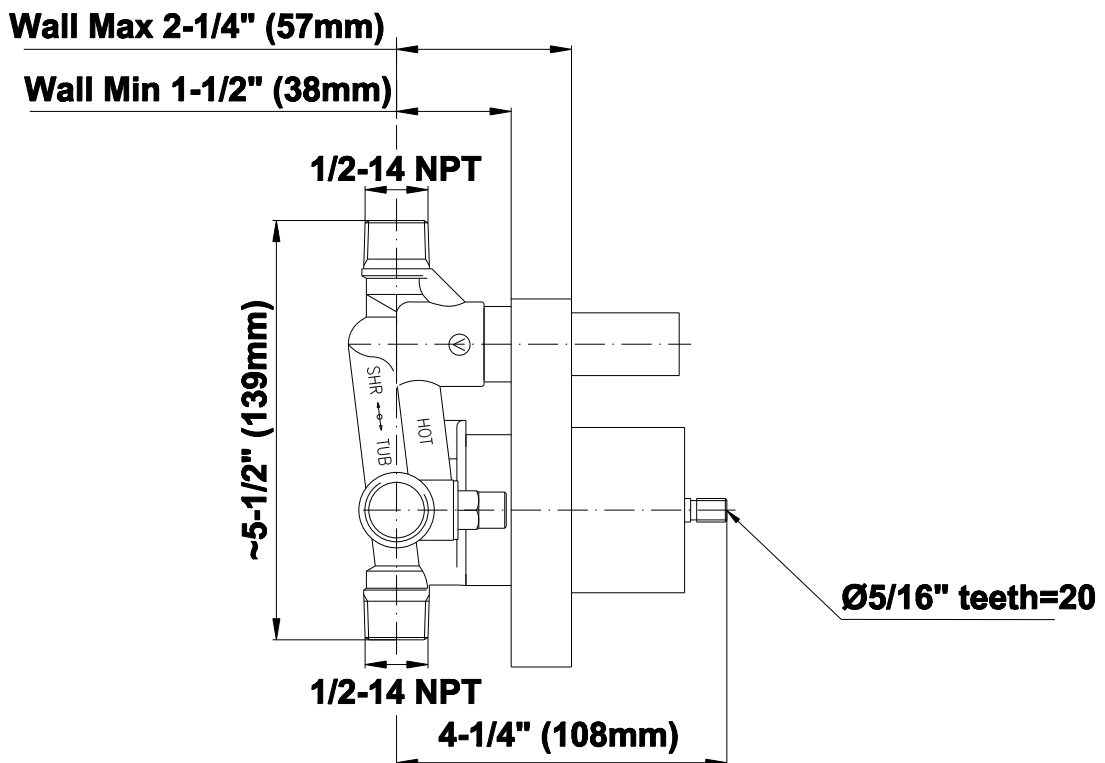

The measurements shown are for reference only. Products and specifications shown are subject to change without notice. Revised 06/2014.

www.graff-faucets.com | phone: 800-954-4723

SHOWER
Finezza 9" Showerhead
G-8406

GRAFF®



Information

- 126 no-clog, easy-clean rubber spray nozzles
- Recommended use with ceiling shower arm
- Recommended for use at no more than 10 degrees tilt
- Showerhead flow rate ≤ 1.8 max gpm
- CALGreen

Finishes



24K Gold



24K Brushed Gold



24K Brushed Gold with Black Accents



Architectural Black™



Brushed Nickel



Gunmetal



Matte Black

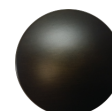

Olive Bronze



Polished Chrome



Polished Chrome with Black Accents



Polished Nickel



Polished Nickel with Black Accents



Unfinished Brass

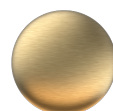

Unfinished Brushed Brass

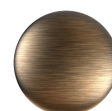

Vintage Brushed Brass



Architectural White

G-8406

Finezza Collection
9" Rain Showerhead

GRAFF[®]
CUTTING EDGE DESIGN

Product Features

- Sunflower shape
- 126 no-clog, easy-clean rubber spray nozzles
- Showerhead flow rate < 1.8 max gpm

Available Finishes

- Polished Chrome
G-8406-PC
- Brushed Nickel
G-8406-BNi
- Polished Nickel
G-8406-PN
- Unfinished Brass*
G-8406-UB*
- Olive Bronze
G-8406-OB*
- Gold*
G-8406-AU*
- Brushed Gold*
G-8406-BAU*

* Special order finish- call for availability



Code Compliance

- CALGreen

Warranty

- Limited lifetime warranty

For complete warranty information go to www.graff-designs.com/en-nam/warranty

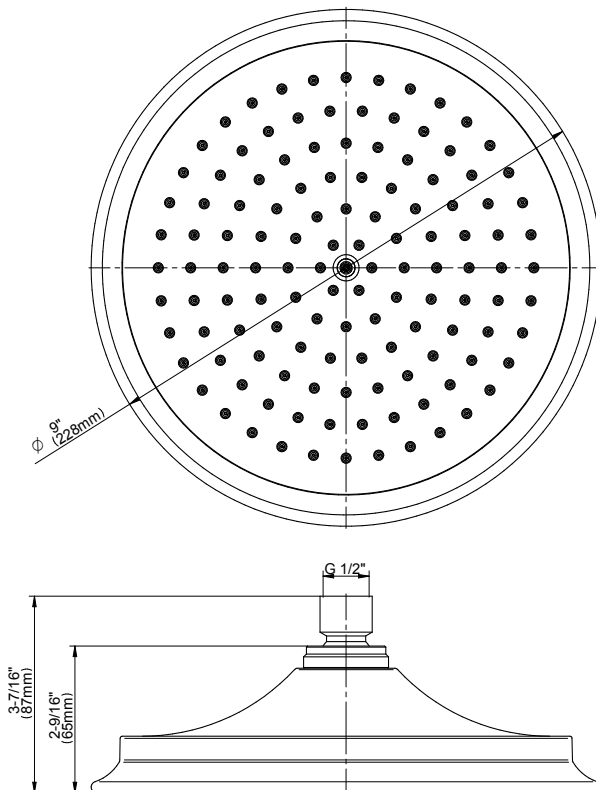

The measurements shown are for reference only. Products and specifications shown are subject to change without notice. Revised 12/2017

www.graff-designs.com | phone: 800-954-4723

SHOWER
Transitional 11" Shower Arm
G-8508

GRAFF®



Information

- Includes arm and flange
- 1/2" NPT male thread inlet
- For use with all showerheads

Finishes



24K Gold



24K Brushed Gold

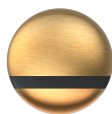

24K Brushed Gold with Black Accents



Architectural Black™

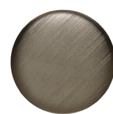

Brushed Nickel

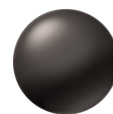

Gunmetal



Matte Black

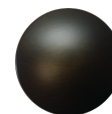

Olive Bronze



Polished Chrome



Polished Chrome with Black Accents



Polished Nickel



Polished Nickel with Black Accents



Unfinished Brass

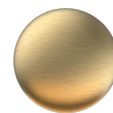

Unfinished Brushed Brass

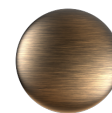

Vintage Brushed Brass

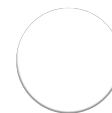

Architectural White

G-8508

Transitional 11" Shower Arm

GRAFF®



Product Features

- Includes arm and round flange
- 1/2" NPT male thread inlet
- For use with all showerheads

Warranty

- Limited lifetime warranty

For complete warranty information go to <https://www.graff-faucets.com/en/info/faqs>

Available Finishes

- Polished Chrome
G-8508-PC
- Brushed Nickel
G-8508-BNi
- Polished Nickel
G-8508-PN
- Unfinished Brass*
G-8508-UB*
- Unfinished Brushed Brass*
G-8508-UBB*
- Matte Black*
G-8508-MBK*
- Architectural Black*
G-8508-BK*
- Architectural White*
G-8508-WT*
- Steelnox (Satin Nickel)*
G-8508-SN*
- Olive Bronze*
G-8508-OB*
- Gunmetal*
G-8508-GM*
- Vintage Brushed Brass*
G-8508-VBB*
- OR'osa PVD*
G-8508-RG*
- Onyx PVD*
G-8508-OX*
- Polished Brass PVD*
G-8508-PB*
- Brushed Brass PVD*
G-8508-BB*
- 24K Gold*
G-8508-AU*
- 24K Brushed Gold*
G-8508-BAU*

* Special order finish- call for availability

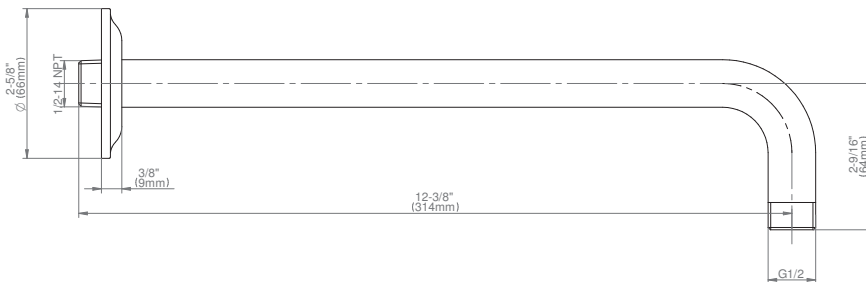

The measurements shown are for reference only. Products and specifications shown are subject to change without notice. Revised 7/2019.

www.graff-designs.com | phone: 800-954-4723