

36" zeroEDGE Side Outlet Channel Drain Body

Model #: 85236-

FEATURES:

- 304 stainless steel construction
- 2" side outlet
- Nominal Size: 36"
- No sub drain required
- Easy install design
- Available in BSS ONLY, as body is not visible
- JACLO grates sold separately



AVAILABLE FINISHES:

Brushed Stainless (BSS)

SPECIFICATION DRAWING:

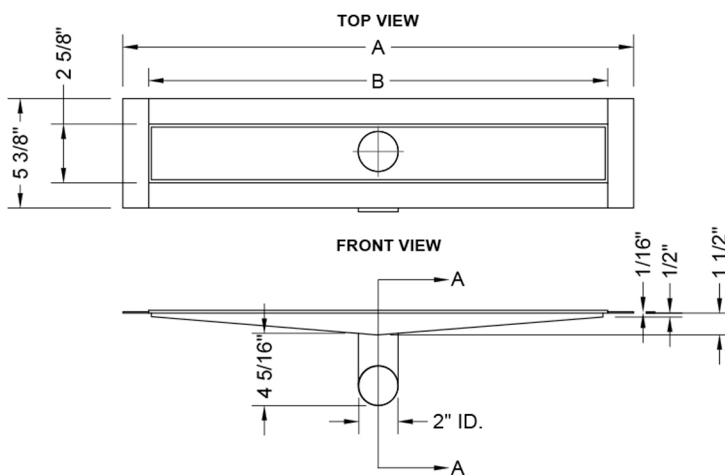

BOTTOM OUTLET SHOWER CHANNEL BODY ONLY				TILE HEIGHT ABOVE FLANGE (Grate Height)	
PART. #	DESCRIPTION	A	B	Z Min.	Z Max.
85224-xxx	24" BOTTOM OUTLET	25 1/8"	22 3/8"	9/16"	1"
85232-xxx	32" BOTTOM OUTLET	33"	30 1/4"	9/16"	1"
85236-xxx	36" BOTTOM OUTLET	36 15/16"	34 1/4"	11/16"	1 1/8"
85242-xxx	42" BOTTOM OUTLET	44 13/16"	42 1/8"	9/16"	1"
85248-xxx	48" BOTTOM OUTLET	48 3/4"	46"	9/16"	1"
85260-xxx	60" BOTTOM OUTLET	60 9/16"	57 1/8"	5/8"	1 1/16"

DETAIL A

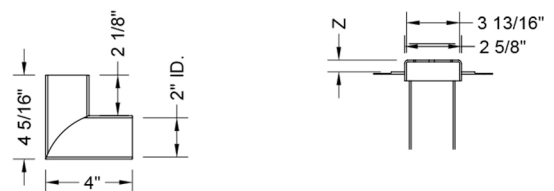

COMPLIANCES:

Complies with: ASME A112.18.2-2015/CSA B125.2-15