



# Verticyl® Oval

Under-mount Bathroom Sink  
**K-2881**

## Features

- Geometric oval basin with vertical sides.
- Overflow drain.
- No faucet holes; requires wall- or counter-mount faucet.
- Fits standard 14- x 17-inch countertop cutout.

## Material

- Vitreous china.

## Installation

- Under-mount

## Recommended Products/Accessories

K-8998 P-Trap

## Included Components

Additional Components:  
1193643 Basin clamps



ADA

## Codes/Standards











ASME A112.19.2/CSA B45.1  
ADA  
ICC/ANSI A117.1

## KOHLER® One-Year Limited Warranty

See website for detailed warranty information.

## Available Colors/Finishes

*Color tiles intended for reference only.*

Color	Code	Description
	0	White
	HW1	Honed White
	96	Biscuit
	47	Almond
	NY	Dune
	95	Ice™ Grey
	G9	Sandbar
	33	Mexican Sand™
	K4	Cashmere
	58	Thunder™ Grey
	7	Black Black™

1-800-4KOHLER (1-800-456-4537)

Kohler Co. reserves the right to make revisions without notice to product specifications.

For the most current Specification Sheet, go to [www.kohler.com](http://www.kohler.com).

9-7-2019 09:05 - US/CA/MX

THE BOLD LOOK  
OF **KOHLER**®

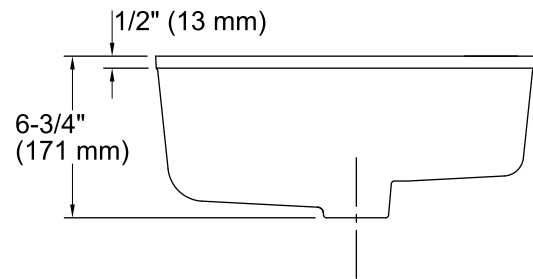
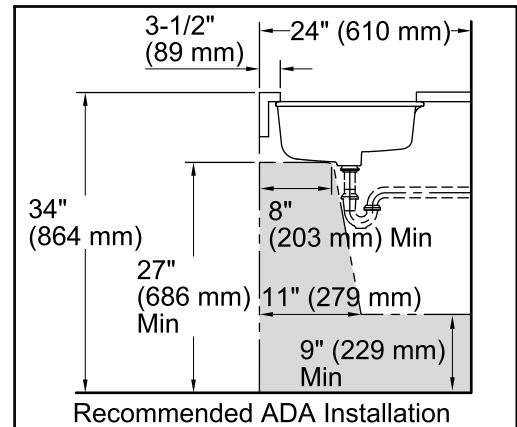
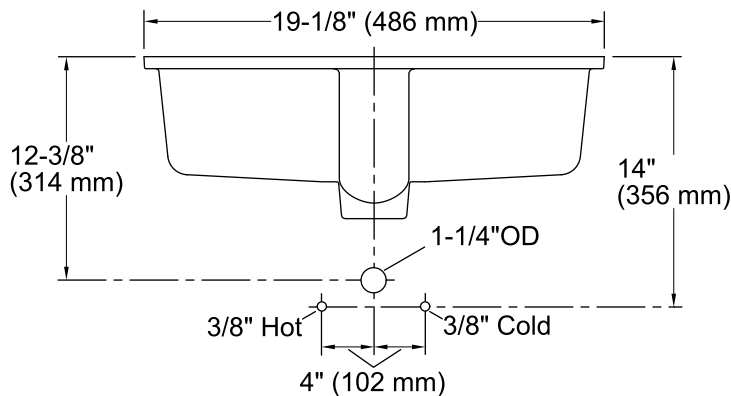
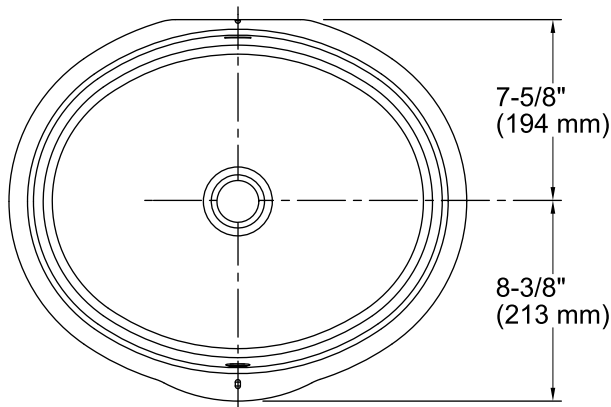

### Technical Information

All product dimensions are nominal.

Bowl configuration:	Single
Installation:	Under-mount
Bowl area (Only):	Length: 17" (432 mm) Width: 14" (356 mm) Water depth: 3-1/8" (79 mm)
Drain hole:	1-3/4" (44 mm)
Template:	1151011-7, required, not included

### Notes

Install this product according to the installation instructions.

**NOTICE:** Countertop manufacturer or cutter must use the current product template available at [www.kohler.com](http://www.kohler.com), or by calling 1-800-4KOHLER. Kohler Co. is not responsible for cutout errors when the incorrect cutout template is used.

ADA compliant when installed to the specific requirements of these regulations.