

# Loft 6631 R-SF - Right hand drain, 1 Skirt (Front)

Product code : **LO6631R-SF**

Draft revision : **20170320140000**

External dimensions : **66" x 31" x 22" [167,6 cm x 78,7 cm x 55,9 cm]**

Series : **freestand**

Seats : **1**

Lumbar support : **yes**

Arm rests : **no**

Low-profile available : **no**

## Draft and specs

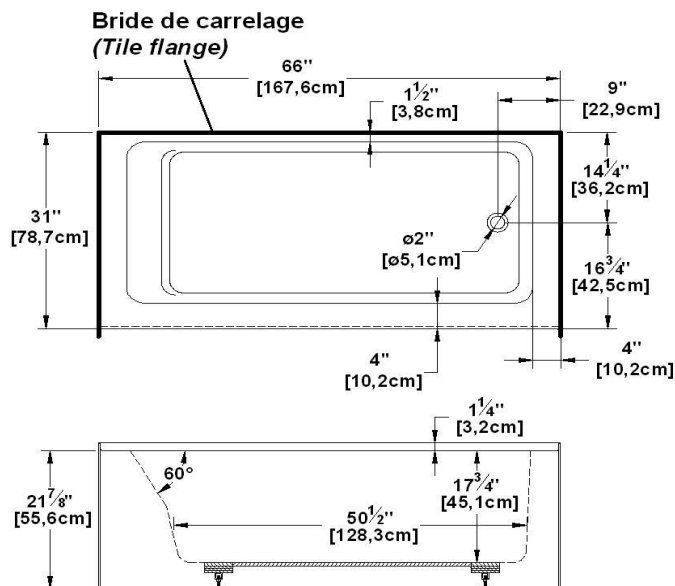

Specifications	
Capacity :	<b>46 IMP Gal. / 60,0 US Gal. / 209,1 liters</b>
AeroMassage™ :	<b>40 Easy Clean™ air jets</b>
Super AeroMassage™ :	<b>AeroMassage™ + 12 Easy Clean™ air jets</b>
Dynamic Turbo™ :	<b>unavailable</b>
Comfort Air™ :	<b>40 Easy Clean™ air jets</b>
Characteristics :	<b>1 integrated skirt</b>

Remarks	
*all measures have a precision of ± 1/4" (0,63cm)	
*internal dimensions taken at 4" (10cm) from bath bottom	
*capacity is measured by filling the soaker to 1-1/2" under the overflow	

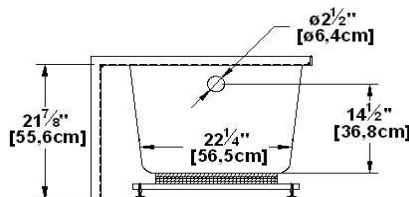

## Options and installation

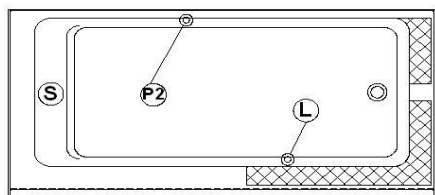

accessories and decorative lines positions are approximative

Additional(s) note(s) :

**Integrated acrylic tile flanges. If system, delivered with keypad not installed. Available in white only. Only one handle can be factory installed.**

Legend			
(S)	Blower	(L)	Chromotherapy light
(P1)	Pump	(P2)	Grab bar
(C)	Keypad		
Recommended faucets drilling location*			
Deck cut-out line			-----

Available models	
Model	Availability
Soaker alone	✓
Comfort Air™	✓
AeroMassage™	✓
Super AeroMassage™	✓
Dynamic Turbo™ (not available in the U.S.)	
Dynamic Turbo™ + AeroMassage™	
Dynamic Turbo™ + Super AeroMassage™	

Available recommended options	
Front skirt :	
Recommended drain : <i>WOCO14 (chrome finish)</i>	
Tile flanges : <i>Included on sides without skirt</i>	
Remote control** : <i>available</i>	
**Floating	

\*It is possible to install the faucets elsewhere on the product. The installer must verify that there are no piping or wires before drilling.

**IMPORTANT NOTE** : Specifications, dimensions and models are subject to change.

Visit our website <http://www.oceania-attitude.com> to access up-to-date dimensions and informations. In all cases, information on the website is the most up-to-date. Dimensions may vary slightly. To ensure proper fit, measurements must be taken on the product directly.

### Head office

591, avenue des Entreprises  
Thetford Mines, Quebec  
CANADA G6H 4B2

### Phone numbers

No-charge : 1-877-332-4224  
Fax : 1-866-460-4334

### Internet

Web : <http://www.oceania-attitude.com>  
Email : [info@oceanibaths.com](mailto:info@oceanibaths.com)